

Schluter®-KERDI-BOARD

Substrate, building panel, bonded waterproofing





Schluter®-KERDI-BOARD

The universal substrate for tiles

Flat. Level. Plumb. Square.

No matter the quality, cost, or extravagance of a tile installation project, the integrity of the tile is only as good as its foundation. Many substrates encountered in new buildings and renovation projects are unsuitable for tile installation, especially in areas with high moisture. This can require comprehensive preparation and waterproofing measures.

Schluter®-KERDI-BOARD, a multifunctional waterproof building panel, gives you more control over your tile installation project by providing you with the means to simply and easily create ideal substrates for tile. Flat, level, plumb, and square substrates are now within reach using KERDI-BOARD.

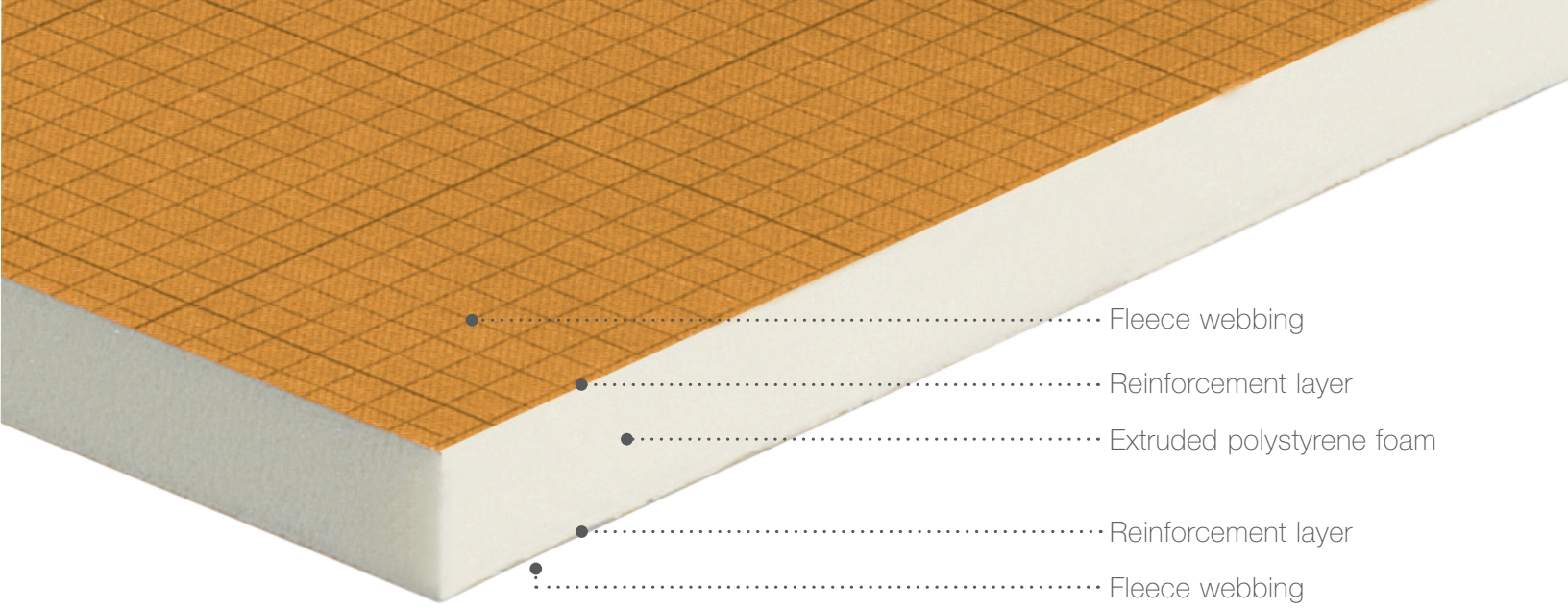

Advantages of KERDI-BOARD

- Uniform, impact-resistant, and rigid
- Waterproof and temperature-resistant
- Thermally insulating and dimensionally stable
- Simple to cut using printed gridlines
- Quick and easy to install
- Lightweight, easy to handle and transport
- Contains no cement or fiberglass
- Designed to create load-bearing tile substrates

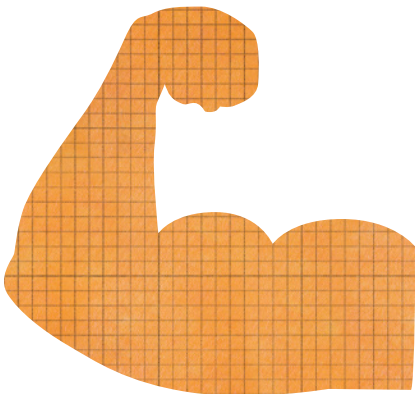

KERDI-BOARD is a versatile building panel that is stable, easy to handle, and can be used to create load-bearing tile substrates. Typical applications include tub surrounds, shower benches and curbs, as well as walls and niches. Due to its composite design, **KERDI-BOARD can hold significant loads in both flexure (e.g., floating shower benches and curbs) and compression (e.g., tub surrounds),** with the largest panels specifically designed for these types of tile applications. Once the KERDI-BOARD panel is tiled and grouted, the assembly becomes even stronger.



Shower & Bathtub Surrounds

Tiled showers and bathtub surrounds require proper moisture management to ensure successful long-term performance. In addition to being lightweight and easy to cut with a utility knife, KERDI-BOARD is inherently waterproof and vapor-retardant. When used in conjunction with the Schlüter®-Shower System, KERDI-BOARD provides an integrated tile backing and moisture management system for tiled showers and bathtub surrounds.



Bathtub Platforms

KERDI-BOARD is easily customizable and inherently waterproof, and thus, the perfect substrate for creating both standard and more intricate bathtub surrounds. Making little-to-no-mess while cutting, you can construct your bathtub platform easily, efficiently, and soundly.







Countertops

Tiled countertops are often constructed with plywood decks, which are dimensionally unstable and moisture-sensitive. Additional work is required to prepare the surface for tile installation, which can be time-consuming.

KERDI-BOARD is particularly suitable for building countertops and other work surfaces with tile coverings. KERDI-BOARD is dimensionally stable and waterproof and can be adhered directly to base cabinets, thus eliminating the need for labor-intensive preparation. Printed gridlines on the board surface allow for the quick and easy cutting of panels and openings.



Suitable panel thicknesses

1-1/2" (38 mm) or 2" (50 mm) are recommended when adhering KERDI-BOARD directly to base cabinets.

Complete the project

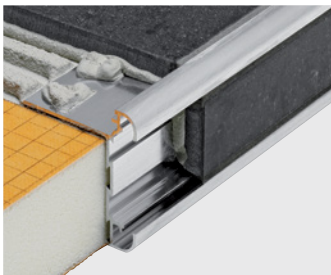

RONDEC-CT

Anodized Aluminum

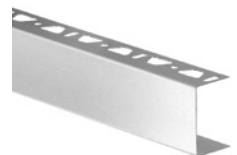

KERDI-BOARD-ZC

Stainless Steel



Vanities & Shelving

Create and customize storage solutions to suit your size and design specifications. Prefabricated vanities do not always fit your spatial situation and building vanities from traditional materials, using framing and sheathing, is time-consuming and labor-intensive. KERDI-BOARD allows you to configure a substrate that is ready for tile and to your liking. Schluter profiles make it easy to finish off the tile edges; there is no need to rely on specialty ceramic trim pieces.

Suitable panel thicknesses

- **2" (50 mm)**-thick panels are suitable for building the structure
- **3/4" (19 mm)**-thick panels can typically be used for shelving





Installation Overview

With eight thicknesses available, KERDI-BOARD can be used to build virtually any kind of substrate. Whether you need to even-out an existing problematic substrate, install a solid backing directly on stud frame structures, or build custom elements such as pipe or column coverings, KERDI-BOARD makes it quick and easy.

For full installation details see the KERDI-BOARD Technical Data Sheet or Shower Installation Handbook.



Over Stud Frame Structures

Stud framing is typically covered with gypsum board. Often, the trades that hang the gypsum board do not take the time to ensure that the finished surfaces are plumb with square corners. Furthermore, gypsum board panels require additional prep, such as waterproofing, prior to setting tile in wet areas.

KERDI-BOARD is quick and easy to install as a substrate for tile coverings over wood or metal framing, and can be used vertically as well as horizontally with panel joints on the studs.

Suitable panel thicknesses

1/2" or 5/8" (12.5 or 15 mm) for studs spaced at 16" o.c.
3/4" (19 mm) for studs spaced at 24" o.c.



Over Existing Uneven Substrates

Masonry walls and existing/mixed substrates are often unsuitable for direct application of tile because they can be uneven or difficult to bond to. KERDI-BOARD can be easily installed on concrete, masonry, and existing and mixed substrates.

Depending on the condition of the existing wall areas, KERDI-BOARD can be either fully embedded in thin-set mortar or spot-bonded. Spot-bonding the panels with thin-set mortar allows for adjustment to achieve plumb wall surfaces. Where wall surfaces will not accept a bond to thin-set mortar, KERDI-BOARD can be further attached with the help of the special anchors included in our hardware assortment.

Suitable panel thicknesses

3/16" (5 mm) for fully embedded panels
3/8" (9 mm) for spot-bonded panels



Partition Walls

Sanitary installations frequently require partition walls to create separate shower or toilet stalls or to divide rooms. The construction of such walls using masonry blocks or stud framing with sheathing is time-consuming and often requires further preparation before tiling can begin. KERDI-BOARD can be used to quickly and simply create stable and self-supporting partition walls for tiling. The partition walls can be further attached or stabilized with the angled and U-shaped profiles, which form part of the complete system. KERDI-BOARD is ideally suited to create anything from simple partitions to entire toilet and shower facilities.

Suitable panel thicknesses

2" (50 mm)



Benches

KERDI-BOARD is the ideal substrate for creating shower benches that are ready for tile. Simple to cut with a utility knife, KERDI-BOARD can be easily customized to fit your bench size and design specifications. Schluter®-KERDI-BAND should be used to seal the edges of the assembly to ensure that the bench is suitably waterproofed.

Suitable panel thicknesses

2" (50 mm)

Prefabricated KERDI-BOARD-SB benches are also available

Rectangular 11-1/2" x 38" x 20" (29 cm x 97 cm x 51 cm)
16" x 48" x 20" (41 cm x 122 cm x 51 cm)

Triangular 16" x 16" x 20" (41 cm x 41 cm x 51 cm)
24" x 24" x 20" (61 cm x 61 cm x 51 cm)

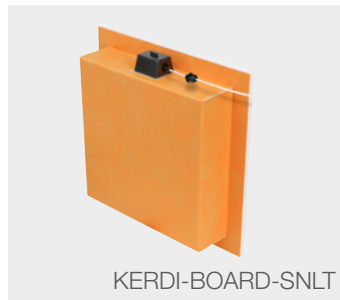
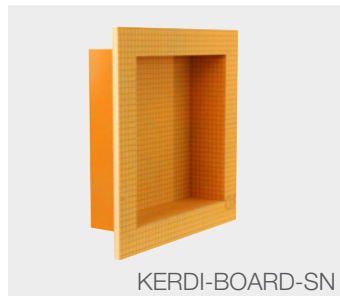

Niches

KERDI-BOARD-SN and KERDI-BOARD-SNLT (with LIPROTEC LED lighting) prefabricated shower niches are fully sealed, quick to install, and combine functionality with décor in the shower. The shower niches integrate seamlessly with Schluter®-KERDI and KERDI-BOARD shower assemblies, and feature pre-sealed inside corners, which can be challenging areas to waterproof. The larger niche sizes include a prefabricated KERDI-BOARD shelf that can be installed at any height to create separate compartments within the niche.

Available sizes, with niche openings measuring:

12" x 6" (305 mm x 152 mm)*
12" x 12" (305 mm x 305 mm)
12" x 20" (305 mm x 508 mm)
12" x 28" (305 mm x 711 mm)

**Size offered for KERDI-BOARD-SN, exclusively.*

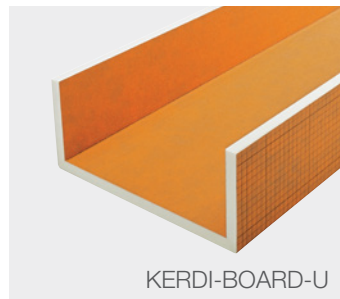

Pipe and Column Covering

Traditional framing around pipes and columns is a labor-intensive process. The innovative, prefabricated L-shaped and U-shaped KERDI-BOARD panels make it especially easy to conceal pipes and columns.

The panels feature V-shaped grooves and are packaged in a space-saving flat design, which makes them easy to store. The flat panels are also quick to cut to the necessary dimensions. Thin-set mortar, Schluter®-KERDI-FIX adhesive or KERDI-BOARD-ZDK double-sided adhesive tape is applied to the V-grooves. The panels are folded prior to installation.

Suitable panel thicknesses

3/4" or 1" (19 or 25 mm)

KERDI-BOARD-V

Schluter®-KERDI-BOARD-V is a vertically grooved substrate and building panel that allows you to take your tiling project to the next level by incorporating rounded and curved elements in your design. As a dimensionally stable substrate, KERDI-BOARD-V can be easily used to create bathtub surrounds, freestanding curved walls, and curved coverings for plumbing elements, duct work, columns, and more.

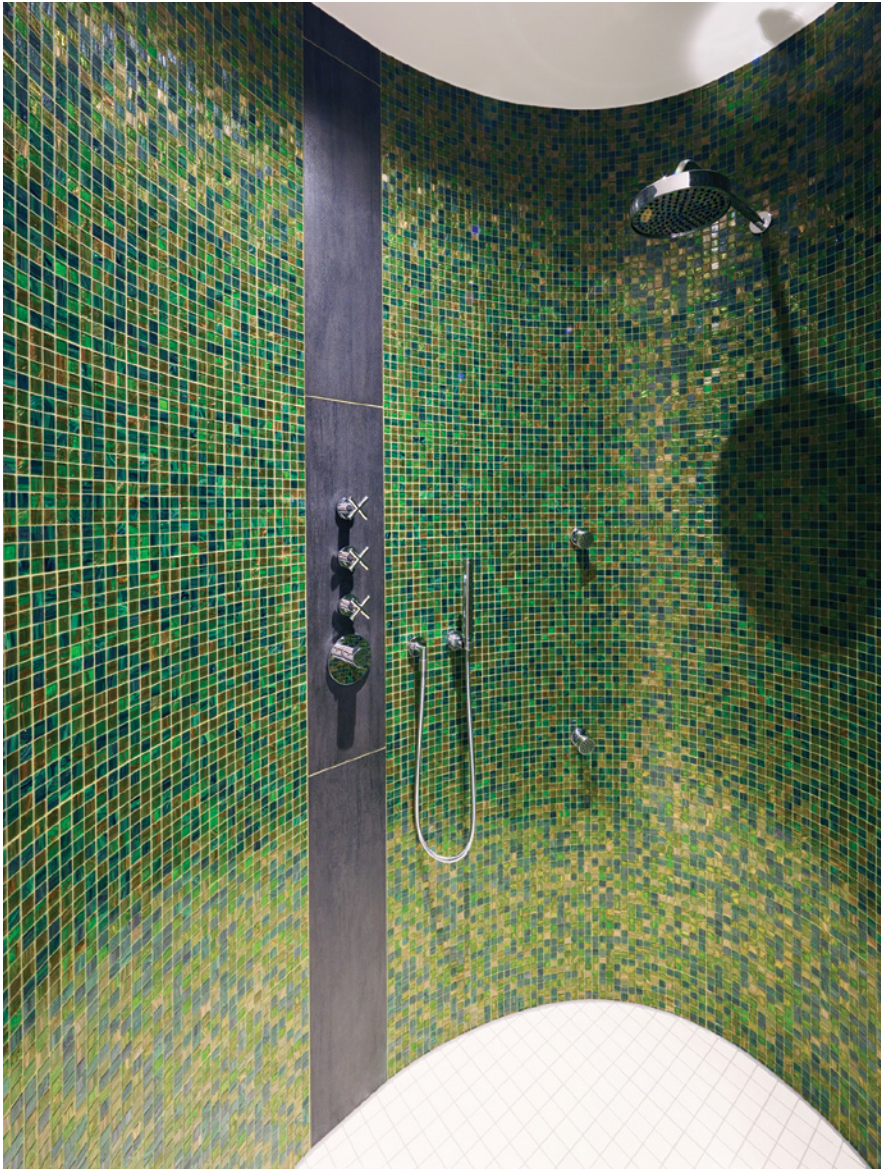

Panel dimension:

24-1/2" x 96" (62.5 cm x 244 cm)

Available thicknesses:

3/4" (19 mm)

1" (25 mm)

1-1/2" (38 mm)

2" (50 mm)

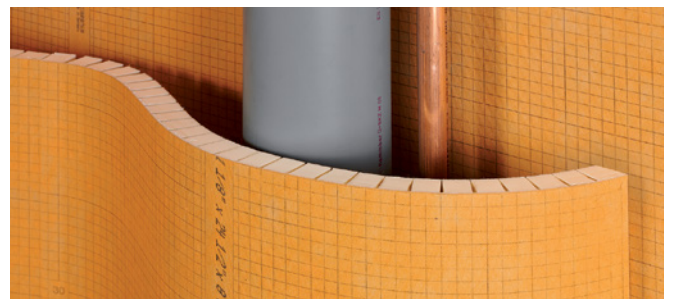



Schluter®-KERDI-BOARD	
Thickness	Dimensions
3/16" - 5 mm	48" x 64" - 122 cm x 162.5 cm 48" x 96" - 122 cm x 244 cm
3/8" - 9 mm	48" x 64" - 122 cm x 162.5 cm 48" x 96" - 122 cm x 244 cm
1/2" - 12.5 mm	48" x 32" - 122 cm x 81 cm 48" x 64" - 122 cm x 162.5 cm 48" x 96" - 122 cm x 244 cm
5/8" - 15 mm	48" x 96" - 122 cm x 244 cm 48" x 120" - 122 cm x 305 cm
3/4" - 19 mm	24-1/2" x 96" - 62.5 cm x 244 cm
1" - 25 mm	24-1/2" x 96" - 62.5 cm x 244 cm
1-1/2" - 38 mm	24-1/2" x 96" - 62.5 cm x 244 cm
2" - 50 mm	24-1/2" x 96" - 62.5 cm x 244 cm

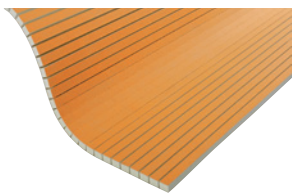

Schluter®-KERDI-BOARD-V



Panel Dimensions
24-1/2" x 96" - 62.5 cm x 244 cm

Thicknesses
3/4" - 19 mm
1" - 25 mm
1-1/2" - 38 mm
2" - 50 mm

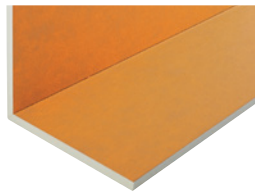

Schluter®-KERDI-BOARD-E



Panel Dimensions
24-1/2" x 96" - 62.5 cm x 244 cm

Thicknesses
3/4" - 19 mm
1" - 25 mm

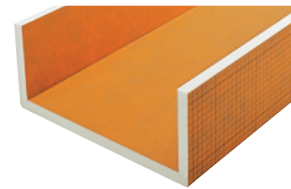

Schluter®-KERDI-BOARD-U



Panel Dimensions
24-1/2" x 96" - 62.5 cm x 244 cm

Thicknesses
3/4" - 19 mm

Accessories

1 **KERDI-BOARD-ZC** is a U-shaped brushed stainless steel profile with a perforated topside, and a smooth underside with anchoring leg for finishing countertops or similar structures.

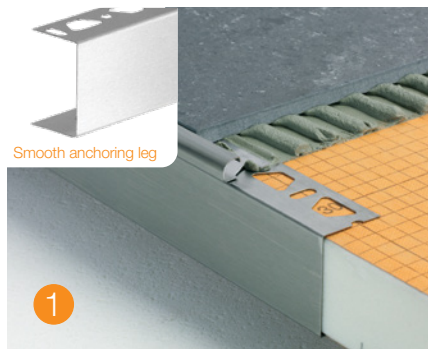

2 **KERDI-BOARD-ZA** is a U-shaped brushed stainless steel profile with two perforated sides designed for visible edges of partition walls and shelves.



3 **KERDI-BOARD-ZFP** is a flat plastic profile that can be attached behind the KERDI-BOARD-ZA for secure attachment of finishing hardware. Ideal for custom glass doors.

4 **KERDI-BOARD-ZB** is a U-shaped stainless steel profile with three perforated sides for the tiling and reinforcement of open-ended partition walls.

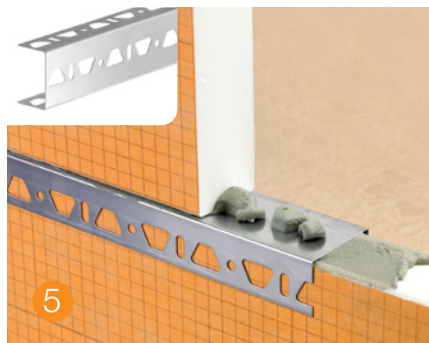

5 To enhance stability, the three-sided, perforated **KERDI-BOARD-ZB** or **KERDI-BOARD-ZW** can be integrated into the joints of a freestanding partition.

6 **KERDI-BOARD-ZW** is a stainless steel angle profile that is designed to create an aligned attachment stop.

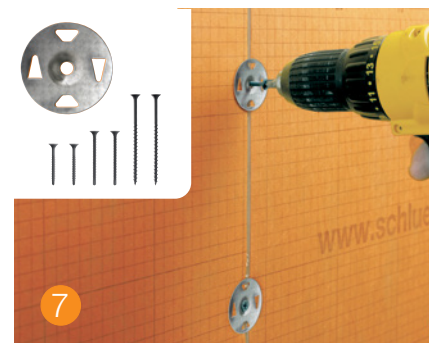

7 **KERDI-BOARD-ZT/-ZS** are installation screws and washers for the quick attachment of KERDI-BOARD to wood stud framing.

8 **KERDI-BOARD-ZSD** are anchors for the additional mechanical attachment of KERDI-BOARD to difficult-to-bond-to substrates.



9 **KERDI-BOARD-ZDK** is double-sided adhesive tape for connecting KERDI-BOARD panels at abutting joints and similar places.

Related Products

KERDI-SHOWER-T/-TS/-TT

Sloped shower trays



KERDI-BAND
Waterproofing strip

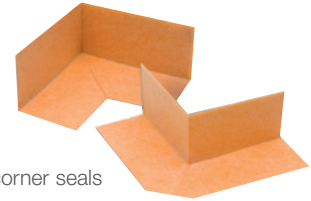

KERDI-KERECK
90° and 135°
inside and outside corner seals



KERDI-FIX
Sealing and bonding compound

KERDI-SEAL-PS/-MV
Pipe and mixing valve seals

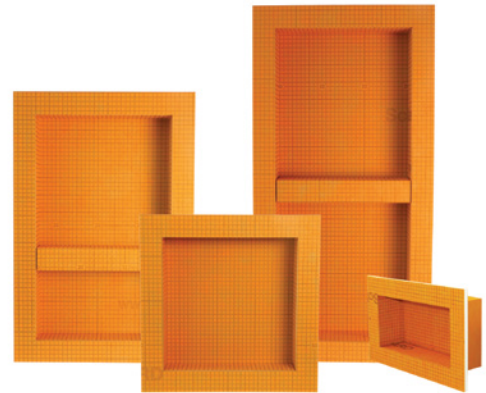
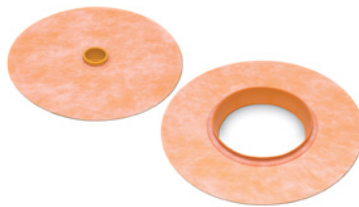

Schluter®-KERDI-BOARD-SN
Niches

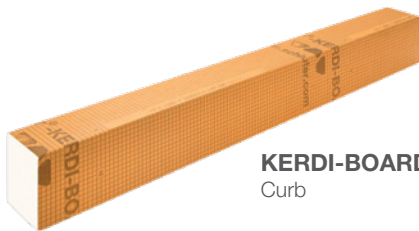

KERDI-BOARD-SC
Curb

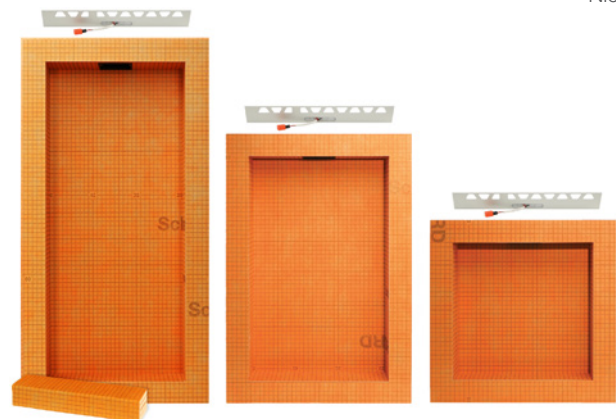

Schluter®-KERDI-BOARD-SNLT
Niches with LIPROTEC LED lighting



KERDI-BOARD-SB
Bench



KERDI-SHOWER-SR
Ramp

KERDI-DRAIN

KERDI-DRAIN is a floor drain with an integrated bonding flange that provides a large contact area for a secure connection to the KERDI waterproofing membrane at the top of the assembly.

Reduces Installation Time and Labor



Eliminates the prep work required in a traditional drain and liner application.

Adaptable

Appropriate for both mortar bed and KERDI-SHOWER-T/-TS/-TT foam tray installations. Ideal for new constructions and remodels.

Designed Specifically for Tile

Fully adjustable grate (vertical, lateral, and tilt) simplifies tile layout and installation. Square grate minimizes awkward cuts around the drain.

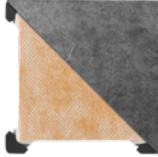
STYLE Brushed Stainless Steel			CLASSIC Stainless Steel	CONTOUR Anodized Aluminum	TILE Tileable covering support
					
PURE	FLORAL	CURVE			
Stainless Steel	Nickel		Stainless Steel	Nickel	
Rose Gold	Vintage Gold	Classic Gold	Chrome	Oil-rubbed Bronze	
Cream	Greige	Stone Grey	Rose Gold	Vintage Gold	
Bronze	Matte Black	Matte White	Classic Gold	Brushed Nickel	
				Brushed Copper	
				Brushed Brass	

Flange Options - 2" or 3"

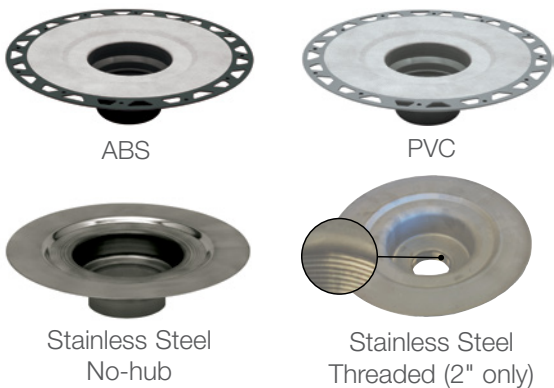

Horizontal Flange Options - 2"

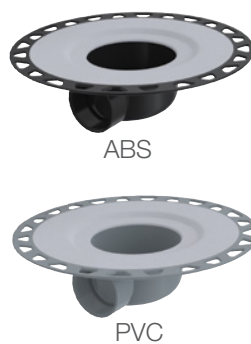

Adaptor - 5-1/4" or 7-1/2"



